



## TIPS FOR GETTING YOUR LICENSE FAST!

### IMPORTANT LINKS

New York DMV: <http://dri.vg/hrh>

DMV CDL Information: <http://dri.vg/s7F>

DMV Appointments: <http://dri.vg/pPy>

Driver License Office Locations: <http://dri.vg/C0n>

Fees: <http://dri.vg/DGH>

### DMV REQUIREMENTS CHECKLIST

- Valid Driver's License
- Medical Certificate: <http://dri.vg/IEh>
- Proof of Identity Documents:  
<http://dri.vg/n4q>

### TESTS YOU WILL NEED TO TAKE

General Knowledge  
Air Brakes (if applicable)  
Pre-Trip Inspection  
Basic Skills  
CDL Road Test  
Vision Exam

#### Applicable exams for desired endorsements:

- Hazardous Materials
- Tank Vehicles
- Passengers
- School Bus
- Double/Triple Trailers
- Metal Coil

Practice exam available online at:  
[www.TestQuestionsAndAnswers.com](http://www.TestQuestionsAndAnswers.com)

# DMV CHEATS and TIPS!

## NEW YORK METAL COIL CDL CHEAT SHEET

### 1. Consequences for drivers who do not follow the Cargo Securement Standard include:

- Delay of trip due to roadside enforcement activity.
- Possible accident resulting in personal injury or death.
- Financial losses to the driver and carrier, such as: loss of shipment, criminal or civil prosecution, increase in insurance rates, clean-up costs after the accident.
- Damage to cargo.

Fundamentals Of Cargo Securement

### 2. The cargo securement standards should be applied to what type of cargo:

- Cargo.
- Dangerous goods/hazardous materials, including equipment carried for vehicle operation.
- Contents of intermodal containers.

Fundamentals Of Cargo Securement

### 3. Cargo must be contained or secured so it does not:

- Leak.
- Spill.
- Blow.
- Fall from.
- Fall through.
- Become dislodged.
- Swing or shift, making the vehicle unstable.

PART II - Performance Criteria for Components of a Securement System





# DMV CHEATS and TIPS!

## NEW YORK METAL COIL CDL CHEAT SHEET

### 4. The securement system **MUST** be capable of resisting:

- The forward force (80% of the cargo weight) represents braking while driving straight ahead.
- The rearward force (50% of the cargo weight) represents vehicle acceleration or braking in reverse.
- The side-to-side or lateral force (50% of the cargo weight) represents traveling on a curve, ramp or changing lanes.
- The vertical force (20% of the cargo weight) represents cargo vibration during transport.

#### PART I - Cargo Securement Performance Criteria

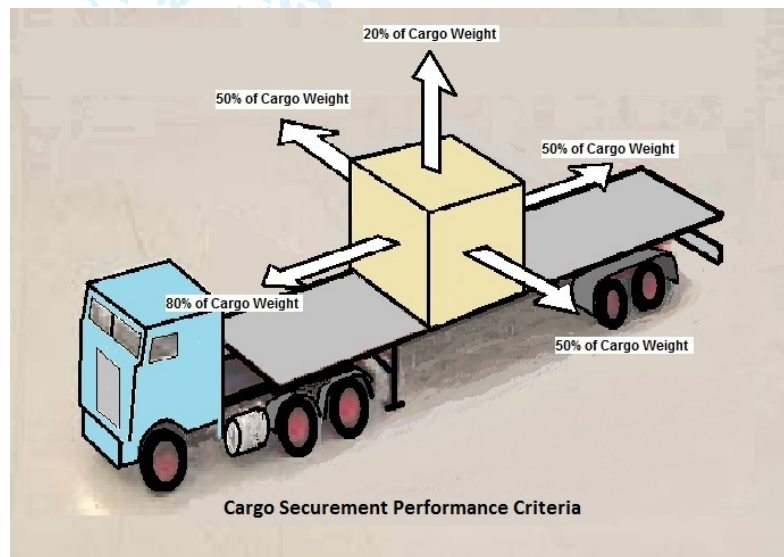

### 5. The securement requirement is satisfied when the cargo is:

- "Fully Contained."

#### PART I - Cargo Securement Performance Criteria

### 6. "g" is the term used for:

- Gravity, and represents acceleration or deceleration.

#### PART I - Cargo Securement Performance Criteria



# DMV CHEATS and TIPS!

## NEW YORK METAL COIL CDL CHEAT SHEET

7. In terms of acceleration or "g", the performance criteria may also be expressed as:

- 0.8 g deceleration in the forward direction.
- 0.5 g deceleration in the rearward direction.
- 0.5 g acceleration in a side-to-side or lateral direction.
- 0.2 g vertical acceleration.

PART I - Cargo Securement Performance Criteria

8. To prevent movement of a steel coil weighing 10,000 lbs. in the forward direction:

- The load securement must provide 8,000 lbs. of securement.

PART I - Cargo Securement Performance Criteria

9. The load securement required to prevent movement of a steel coil weighing 10,000 lbs. in the forward direction can be expressed as:

- 80% of the cargo weight (or 0.8 g).

PART I - Cargo Securement Performance Criteria

10. Cargo that fills a sided vehicle of adequate strength is considered to be:

- Fully contained.

PART I - Cargo Securement Performance Criteria

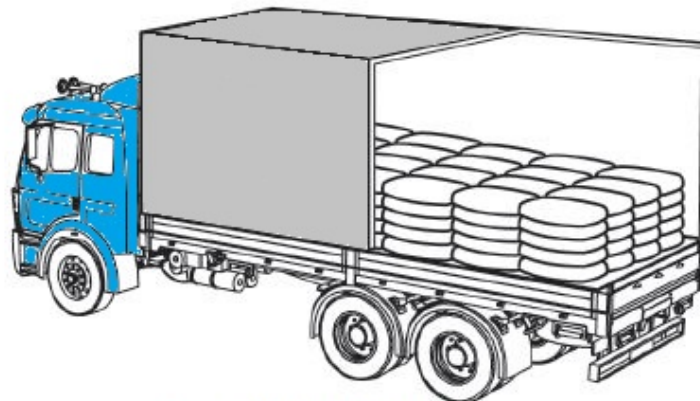

Fully Contained

# DMV CHEATS and TIPS!

## NEW YORK METAL COIL CDL CHEAT SHEET

11. Each component of the cargo securement system should not exceed its:

- Working Load Limit (WLL).

PART II - Performance Criteria for Components of a Securement System

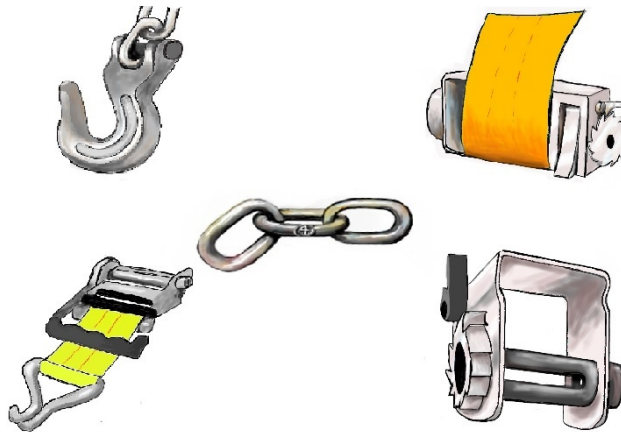

Components Of A Securement System

12. The Working Load Limit is the:

- Maximum load that may be applied to a component of a cargo securement system during normal service.

PART II - Performance Criteria for Components of a Securement System

13. The Working Load Limit of a component is usually assigned by the:

- Manufacturer of the component.

PART II - Performance Criteria for Components of a Securement System

14. Each force in the performance criteria is to be applied:

- Separately to the securement system to determine if it is compliant.

PART II - Performance Criteria for Components of a Securement System

# DMV CHEATS and TIPS!

## NEW YORK METAL COIL CDL CHEAT SHEET

15. When the securement system is not adequate, the system will fail in one of the following three failure modes:

- Rolling.
- Sliding.
- Tipping.

Section 2 General Provisions and Requirements

16. Securement systems are made up of the following categories:

- Category 1 - Vehicle Structure and Anchor Points, Cargo Securement Responsibility and Cab Shields.
- Category 2 - Securement Methods.
- Category 3 - Devices, Assemblies and Components.
- Category 4 - Dunnage Materials.

Section 2 General Provisions and Requirements

17. According to federal and state regulations, ensuring that the vehicles, anchor points and other securement components are in good working order, with no obvious signs of damage are the responsibility of the:

- Carrier and driver.

Section 2 - Category1 -Vehicle Structure and Anchor Points:

18. The carrier and driver are responsible for ensuring that the vehicles, anchor points and other securement components are in good working order, with no obvious signs of damage according to:

- Federal and state regulations.

Section 2 - Category1 -Vehicle Structure and Anchor Points:

19. If securement equipment fails roadside inspection:

- It is likely that the vehicle may be placed out-of-service, and the motor carrier and/or the driver may be fined.

Section 2 - Category1 -Vehicle Structure and Anchor Points:

20. Because metal coils are different in size, shape, weight and other properties, the shipper and the carrier should:

- Devise a securement method that is suited to the characteristics of the cargo, and that meets the performance criteria.

Section 2 - Category 2 - Securement Method:

# DMV CHEATS and TIPS!

## NEW YORK METAL COIL CDL CHEAT SHEET

21. Because the shipper usually packages cargo, the shipper needs to:

- Make sure that the packages are strong enough to withstand the forces during transport.

Section 2 - Category 3 - Securement Devices, Assemblies and Components - Packaging:

22. After performing an inspection, informing the carrier that packaging is not adequate is the responsibility of the:

- Driver.

Section 2 - Category 3 - Securement Devices, Assemblies and Components - Packaging:

23. Where practicable, all tiedowns must be:

- Inside of the rub rail.

Section 2 - Category 3 - Securement Devices, Assemblies and Components - Packaging:

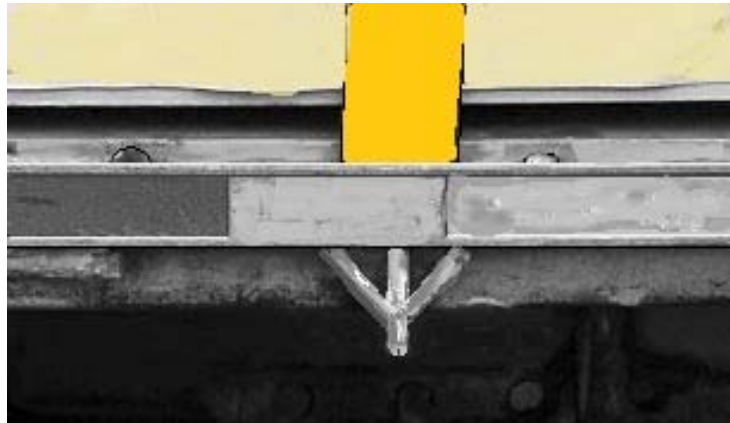

Tiedown within Rubrail

24. There are two types of tiedowns that are used to restrain cargo:

- Direct tiedowns.
- Indirect tiedowns.

Section 2 - Category 3 - Securement Devices, Assemblies and Components - Packaging:

25. Indirect tiedowns restrains the cargo by:



# DMV CHEATS and TIPS!

## NEW YORK METAL COIL CDL CHEAT SHEET

- Creating a downward force that increases the friction between the cargo and the deck.

Section 2 - Category 3 - Securement Devices, Assemblies and Components - Packaging:

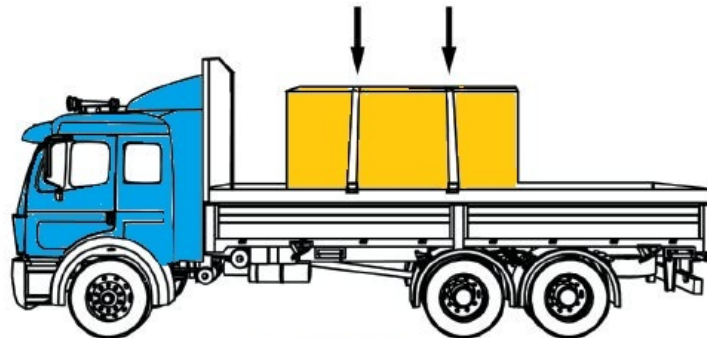

Indirect Tiedown

26. Tiedowns that provide direct resistance to oppose the forces that are acting on the cargo are known as:

- Direct tiedowns.

Section 2 - Category 3 - Securement Devices, Assemblies and Components - Packaging:

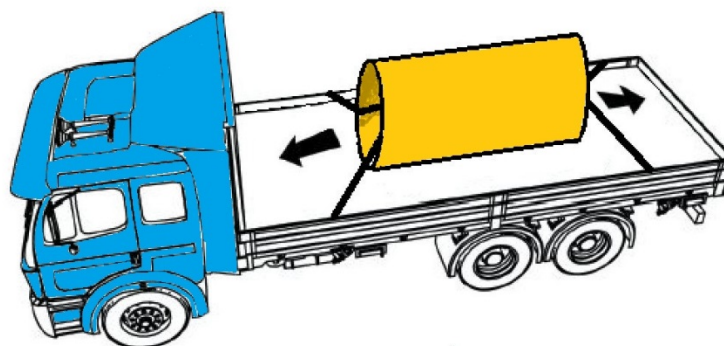

Direct Tiedown

27. Each tiedown must be attached and secured so it:

# DMV CHEATS and TIPS!

## NEW YORK METAL COIL CDL CHEAT SHEET

- Does not become loose or unfastened while the vehicle is in transit.

Section 2 - Category 3 - Securement Devices, Assemblies and Components - Packaging:

### 28. All tiedown parts must be within:

- The rub rails for platform type vehicles.

Section 2 - Category 3 - Securement Devices, Assemblies and Components - Packaging:

### 29. Edge protection must be used if:

- A tiedown may be cut or worn.

Section 2 - Category 3 - Securement Devices, Assemblies and Components - Packaging:

### 30. When used, edge protection must:

- Resist crushing, cutting and abrasion.

Section 2 - Category 3 - Securement Devices, Assemblies and Components - Packaging:

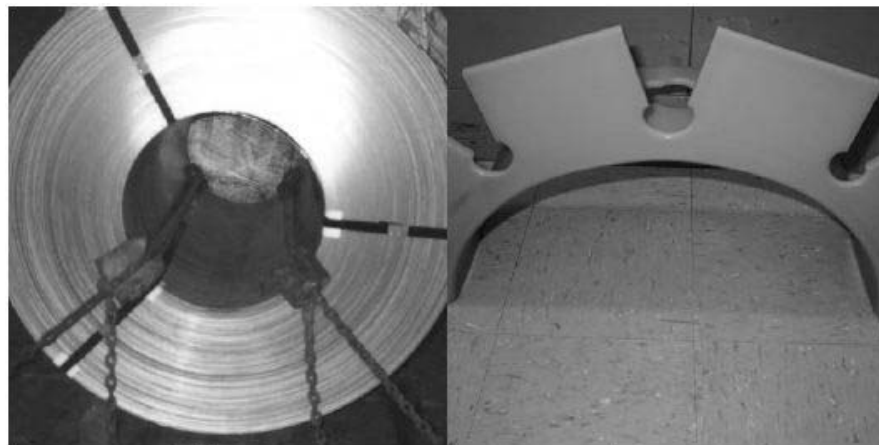

*Use of edge protection*

*Edge protector*

### 31. An edge protection device should fit properly:



# DMV CHEATS and TIPS!

## NEW YORK METAL COIL CDL CHEAT SHEET

- On the edge of the article, with no space under the device for it to crush into.

Section 2 - Category 3 - Securement Devices, Assemblies and Components - Packaging:

**32. Timber used between tiedowns and cargo is known as:**

- **Dunnage materials.**

Section 2 - Category 4 - Dunnage Materials:

**33. When timber is used for structural purposes like blocking and bracing:**

- The grain should run lengthwise along the timber.
- It should be free of knots, knotholes and splits that may affect its strength or interfere with nailing.

Section 2 - Category 4 - Dunnage Materials:

**34. All types of cargo must satisfy one of the following three conditions when being secured:**

- Fully contained by structures of adequate strength.
- Immobilized by structures of adequate strength to prevent shifting or tipping.
- Immobilized on or within a vehicle by appropriate means to prevent shifting or tipping.

General Securement Requirements - Securement Options:

**35. The Working Load Limit is:**

- The maximum load that may be applied to a component of a cargo securement system during normal service.

Working Load Limit:

**36. The Working Load Limit's value is:**

- Assigned by the component manufacturer or the default rating in the Working Load Limit Table.

Working Load Limit:



# DMV CHEATS and TIPS!

## NEW YORK METAL COIL CDL CHEAT SHEET

37. Welded steel chain that is not marked or labeled with a grade or working load limit, is considered to have a working load limit equal to that for:

- Grade 30 proof coil chain.

Working Load Limit:

38. According to the Working Load Limit (WLL) table, the working load limit for a 5/8 inch diameter nylon rope is:

- 935 lbs.

Working Load Limit:

39. According to the Working Load Limit (WLL) table, the working load limit for 2 inch wide synthetic webbing is:

- 2,000 lbs.

Working Load Limit:

40. The working load limit of all components used to block cargo from forward movement must be:

- 50% (or more) of the weight of the article being blocked.

Strength Rating for Blocking Systems:

41. The most important securement task is to:

- Prevent an article from moving forward.

Strength Rating for Blocking Systems:

42. Immobilizing the cargo to prevent forward movement can be done by:

- Placing it against a headboard, bulkhead, stakes or other vehicle structure, or against other cargo that is immobilized in that manner.

Strength Rating for Blocking Systems:

# DMV CHEATS and TIPS!

## NEW YORK METAL COIL CDL CHEAT SHEET

43. A “void-filler” is:

- Material used to fill a space between articles of cargo and the structure of the vehicle that has sufficient strength to prevent movement of the articles of cargo.

Strength Rating for Blocking Systems:

44. An example of a “void filler” is:

- 4 ft. x 4 ft. timbers placed between two adjacent articles of cargo to fill the void.

Strength Rating for Blocking Systems:

45. A \_\_\_\_\_ can also be used to secure cargo against forward movement.

- Direct tiedown

Strength Rating for Blocking Systems:

46. In accordance with the standard of the National Association of Chain Manufacturers, a piece of grade 7 chain may be marked with a:

- 7 or 70.

Securement System Strength Rating for Marked Components:



Manufacturers Marked  
Working Load Limit Value

# DMV CHEATS and TIPS!

## NEW YORK METAL COIL CDL CHEAT SHEET

**47. Tiedowns that restrain the cargo by creating a downward force that increases the friction between the cargo and the deck are known as:**

- **Indirect tiedowns.**

Section 2 - Category 3 - Securement Devices, Assemblies and Components - Packaging:

**48. If markings cannot be read, the tiedown will be considered:**

- **Unmarked.**

Securement System Strength Rating for Marked Components:

**49. Friction mats provide a resistance to horizontal movement equal to:**

- **50% of the cargo weight that is resting on the mat.**

Securement System Strength Rating for Marked Components:

**50. Articles of cargo that are placed beside each other and secured by side-to-side, indirect tiedowns must be either:**

- **Placed in direct contact with each other, or**
- **Prevented from shifting towards each other.**

Cargo Placement and Restraint:

**51. If there are gaps between articles:**

- **Some tiedowns lose their initial tension very quickly in normal driving.**

Cargo Placement and Restraint:

**52. The requirement that articles must be placed in contact with each other or secured to prevent them from moving towards each other in transit:**

- **Applies to all layers and stacks of articles that are loaded across a vehicle.**

Cargo Placement and Restraint:

# DMV CHEATS and TIPS!

## NEW YORK METAL COIL CDL CHEAT SHEET

53. If an article that a tendency to roll cannot be placed against a vehicle structure of adequate strength, then it must be:

- Lifted from the deck and have chocks, wedges, a cradle or some other means to prevent rolling.

Cargo Roll Prevention

54. The method used to prevent rolling must not:

- Become unfastened or loose while the vehicle is in transit.

Cargo Roll Prevention

55. Supporting a single large or heavy article off the deck will eliminate:

- The tendency for securement systems to loosen due to repeated rocking in transit.

Cargo Roll Prevention

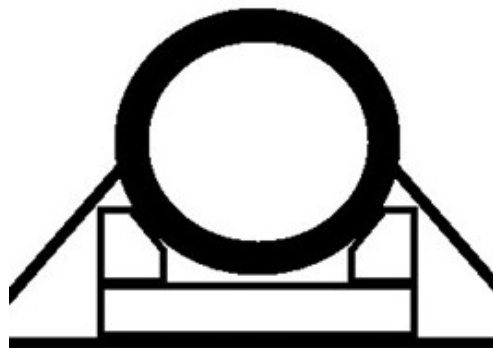

45 Degree Cradle

56. To eliminate the tendency of securement systems to loosen due to repeated rocking in transit:

- Support a single large or heavy article off the deck.

Cargo Roll Prevention

# DMV CHEATS and TIPS!

## NEW YORK METAL COIL CDL CHEAT SHEET

57. Cradles that provide the most restraining force have angles of:

- 45 degrees

Cargo Roll Prevention

58. Where multiple similar articles are placed against each other, the tendency to rock can be controlled if:

- Tiedowns through the two end articles pull the articles together, as required for multiple coils.

Cargo Roll Prevention

59. The sum of the working load limits from all tiedowns must be:

- At least 50% of the weight of the cargo.

Aggregate Working Load Limit for Tiedowns:

60. For tiedowns which are attached to the vehicle that go around, through or over the article and are reattached to the same side of the vehicle, the manufacturer's working load limit is:

- Reduced by 50%.

Aggregate Working Load Limit for Tiedowns:

61. The manufacturer's working load limit is reduced by 50% for tiedowns:

- Which are directly attached from the vehicle to the article.
- Attached to the vehicle that go around, through or over the article and are reattached to the same side of the vehicle.

Aggregate Working Load Limit for Tiedowns:

62. Direct tiedowns, as defined, will have a:

- 50% reduction from the manufacturer's rating or the default rating.

Aggregate Working Load Limit for Tiedowns:

# DMV CHEATS and TIPS!

## NEW YORK METAL COIL CDL CHEAT SHEET

63. Tiedowns above the minimum requirement should be used if:

- They are needed to secure an article against any movement.

Aggregate Working Load Limit for Tiedowns:

64. If there is low friction between cargo and the deck (which can be caused by snow, ice, sand, gravel and oil):

- Direct tiedowns or a means to improve friction (for example, friction mats) should be used.

Aggregate Working Load Limit for Tiedowns:

65. A direct tiedown resists:

- The performance criteria forces that are applied to the cargo.

Purpose of Direct Tiedowns:

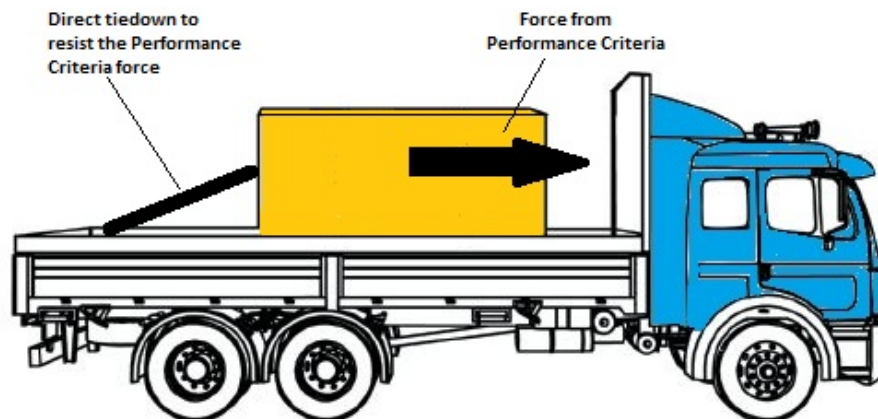

# DMV CHEATS and TIPS!

## NEW YORK METAL COIL CDL CHEAT SHEET

66. A direct tiedown is considered effective against forward and rearward forces if it:

- Makes an angle less than 45 degrees when viewed from the side of the vehicle.

Angles Required When Using Direct Tiedowns:

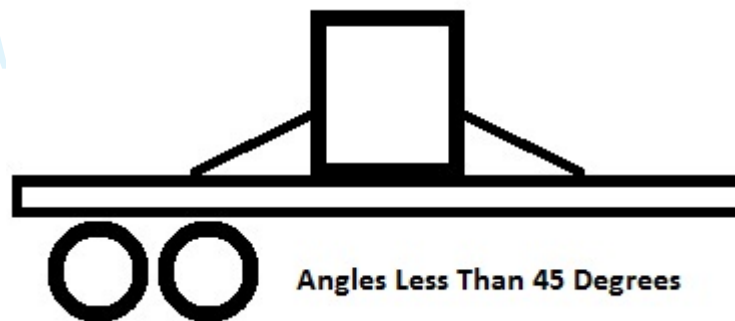

67. A direct tiedown is considered effective against side-to-side forces if it:

- Makes an angle less than 45 degrees with the horizontal when viewed from the front or rear of the vehicle.

Angles Required When Using Direct Tiedowns:

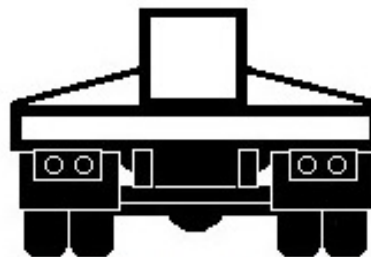

Angles Less Than 45  
Degrees From The Rear

68. When calculating the aggregate working load limit, for each direct tiedown attached to both sides of the vehicle, the working load limit should be counted as:

- 100%.



# DMV CHEATS and TIPS!

## NEW YORK METAL COIL CDL CHEAT SHEET

Calculating Working Load Limits for Direct Tiedowns:

**69. When calculating the aggregate working load limit, for each direct tiedown attached to only one side of the vehicle, the aggregate working load limit should be counted as:**

- 50%.

Calculating Working Load Limits for Direct Tiedowns:

**70. When calculating the aggregate working load limit of all direct tiedowns count:**

- 50% of the working load limit for each tiedown attached to only one side of the vehicle.

Calculating Working Load Limits for Direct Tiedowns:

**71. If you are using two chains, each of which have a working load limit of 4,000 lbs. and are attached to each side of the vehicle, their aggregate working load limit would be:**

- 8,000 lbs.

Calculating Working Load Limits for Direct Tiedowns:

**72. If you are using two chains, each of which have a working load limit of 4,000 lbs. and each is attached with one end on the load and the other end to the vehicle, their aggregate working load limit would be:**

- 4,000 lbs.

Calculating Working Load Limits for Direct Tiedowns:

**73. The purpose of the indirect tiedown is to:**

- Increase the pressure of the article on the deck (that is, to increase the frictional force between the article and the deck).

Purpose of Indirect Tiedowns

**74. An indirect tiedown has failed if:**

- The article shifts.

Purpose of Indirect Tiedowns

# DMV CHEATS and TIPS!

## NEW YORK METAL COIL CDL CHEAT SHEET

75. An indirect tiedown that is used to prevent front-to-back cargo movement must make an angle of:

- At least 30 degrees with the deck when viewed from the side of the vehicle.

Angles Required for Using Indirect Tiedowns:

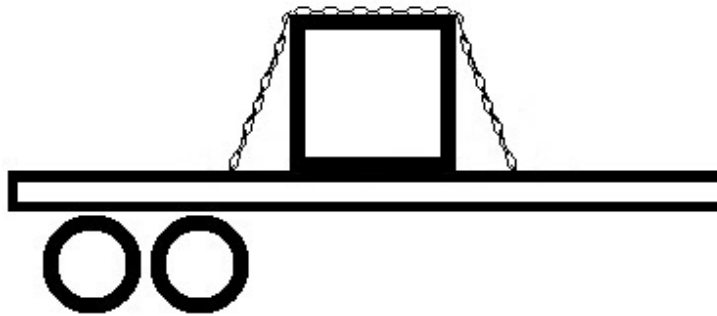

Indirect 30 Degree Angle From The Side

76. An indirect tiedown that is used to prevent side-to-side movement must make an angle of:

- At least 30 degrees when viewed from the front or back of the vehicle.

Angles Required for Using Indirect Tiedowns:

# DMV CHEATS and TIPS!

## NEW YORK METAL COIL CDL CHEAT SHEET

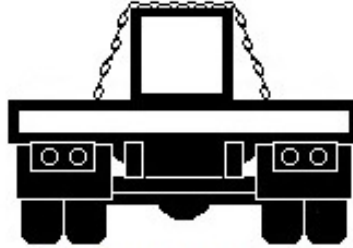

Indirect 30 Degree  
Angle From Rear

**77. An indirect tiedown should be tensioned to as high an initial tension as possible, at least:**

- **50% of its working load limit.**

Angles Required for Using Indirect Tiedowns:

**78. The tension on an indirect tiedown should be maintained:**

- **Throughout the trip.**

Angles Required for Using Indirect Tiedowns:

**79. Each tiedown that passes over an article is considered to be:**

- **1 tiedown.**

Calculating Working Load Limits for Indirect Tiedowns:

# DMV CHEATS and TIPS!

## NEW YORK METAL COIL CDL CHEAT SHEET

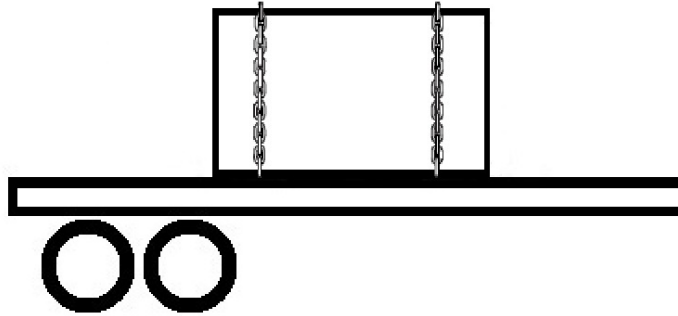

Indirect Tiedown Aggregate Working Load Limit

**80. The aggregate working load limit of all indirect tiedowns is the:**

- **Sum of the working load limits of each indirect tiedown.**

Calculating Working Load Limits for Indirect Tiedowns:

**81. Unless secured by a headboard, bulkhead, other cargo or direct tiedown, the minimum number of indirect tiedowns for an article that is 1.52m (5 ft.) or shorter; 500 kgs. (1,100 lbs.) or lighter is:**

- **One.**

Minimum Number of Indirect Tiedowns Required:

**82. Unless secured by a headboard, bulkhead, other cargo or direct tiedown, the minimum number of indirect tiedowns for an article that is between 1.52+m (5+ft.) and 3.04m (10 ft.) is:**

- **Two.**

Minimum Number of Indirect Tiedowns Required:

**83. Unless secured by a headboard, bulkhead, other cargo or direct tiedown, the minimum number of indirect tiedowns for an article that is between longer than 3.04m (10 ft.) is:**

- **Two + 1 tiedown for every additional 3.04m (10 ft.), or part thereof.**

Minimum Number of Indirect Tiedowns Required:

# DMV CHEATS and TIPS!

## NEW YORK METAL COIL CDL CHEAT SHEET

**84. The driver is responsible for inspecting the cargo and securing devices:**

- Within the first 50 miles.
- Whenever the duty status of the driver changes.
- After 150 miles.

Inspection of Securement Systems:

**85. The driver is responsible for adjusting the cargo and/or securing devices:**

- As necessary.

Inspection of Securement Systems:

**86. If adjustments need to be made at any inspection, the driver must make them, or:**

- Must add devices (as necessary) to ensure that the load is properly secured.

Inspection of Securement Systems:

**87. Tiedowns for a single metal coil with eyes vertical must be arranged in the following manner to prevent the coils from tipping in the forward, rearward and side-to-side (lateral) directions:**

- At least one indirect tiedown attached diagonally from the left side of the vehicle, across the eye of the coil, to the right side of the vehicle;
- At least one indirect tiedown attached diagonally from the right side of the vehicle, across the eye of the coil, to the left side of the vehicle;
- At least one indirect tiedown attached side-to-side over the eye of the coil;
- Either blocking and bracing, friction mats or direct tiedowns must be used to prevent forward -rearward movement.

Single Metal Coil with Eyes Vertical:



# DMV CHEATS and TIPS!

## NEW YORK METAL COIL CDL CHEAT SHEET

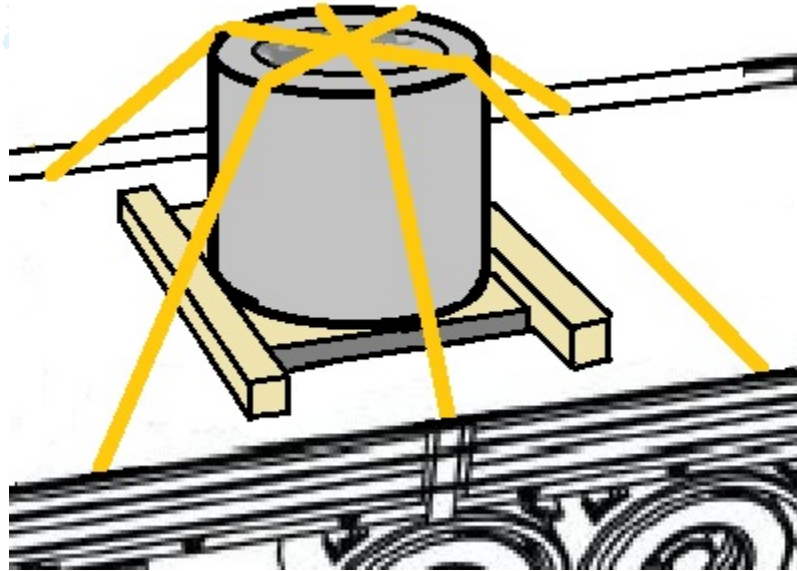

**Single Metal Coil With Eyes Vertical**

**88. The sum of the working load limits from all tiedowns must be:**

- At least 50% of the weight of the coils.

Single Metal Coil with Eyes Vertical:

**89. When the deck or coil is soaked with oil:**

- You should always use a friction mat under each pallet to increase the friction between the pallet and the deck.

Row of Metal Coils with Eyes Vertical:

**90. To prevent rocking of a metal coil positioned with the eye crosswise:**

- The coil must be supported above the deck.

Metal Coils With Eyes Crosswise:

# DMV CHEATS and TIPS!

## NEW YORK METAL COIL CDL CHEAT SHEET

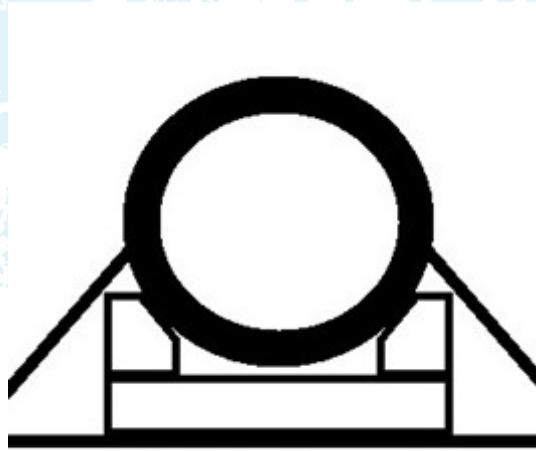

45 Degree Cradle

91. If timbers, chocks or wedges are used for a metal coil positioned with the eye crosswise:

- They must be held in place by coil bunks or similar devices to prevent them from coming loose.

Metal Coils With Eyes Crosswise:

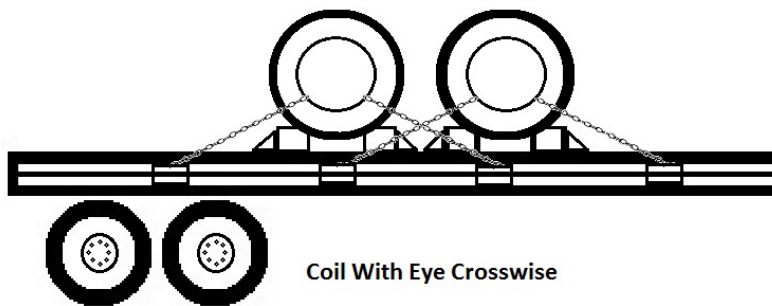

Coil With Eye Crosswise

92. If a direct tiedown is used around the front of the cradle for a metal coil positioned with the eye crosswise:

- It does not count towards the aggregate working load limit for tiedowns through the eye of the coil.



# DMV CHEATS and TIPS!

## NEW YORK METAL COIL CDL CHEAT SHEET

Metal Coils With Eyes Crosswise:

**93. To restrict forward movement of a metal coil positioned with the eye crosswise:**

- At least one direct tiedown is required through its eye.

Metal Coils With Eyes Crosswise:

**94. If more than two chains are required to restrict rearward motion for a metal coil positioned with the eye crosswise:**

- They should be placed symmetrically on either side of the coil.

Metal Coils With Eyes Crosswise:

**95. If an odd number of chains are required to restrict rearward motion for a metal coil positioned with the eye crosswise:**

- The last chain should be to the rear.

Metal Coils With Eyes Crosswise:

**96. In sided vehicles or intermodal containers without anchor points coils must be prevented from horizontal movement or from tipping, by use of:**

- Friction mats.
- System of blocking and bracing.
- Tiedowns and blocking.
- Tiedowns and bracing.

Row of Metal Coils with Eyes Lengthwise:

**97. Option #2 for securing a metal coil positioned with the eye lengthwise is:**

- The same as Option #1, except the direct tiedowns are straight instead of diagonal.

Individual Metal Coils with Eyes Lengthwise:



# DMV CHEATS and TIPS!

## NEW YORK METAL COIL CDL CHEAT SHEET

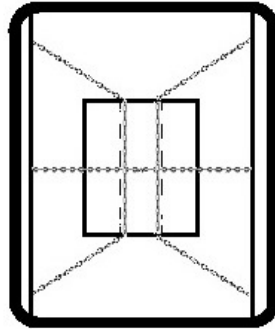

Coil With Eyes Lengthwise  
Option 2

98. Option #3 for securing a metal coil positioned with the eye lengthwise is:

- The same as Option #1 and #2, except the two direct tiedowns are replaced with two indirect tiedowns over the front and rear parts of the coil.

Individual Metal Coils with Eyes Lengthwise:

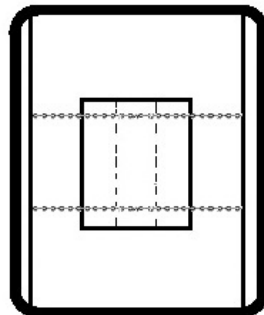

Coil With Eyes Lengthwise  
Option 3

99. In sided vehicles or intermodal containers without anchor points:

- The carrier/driver must ensure that the securement system meets the performance criteria requirements.



# **DMV CHEATS and TIPS!**

## **NEW YORK METAL COIL CDL CHEAT SHEET**

Row of Metal Coils with Eyes Lengthwise:



# DMV CHEATS and TIPS!

## NEW YORK METAL COIL CDL CHEAT SHEET

**Working Load Limits Table**

Working Load Limits (WLL), Chain					
WLL in Pounds					
Size inches	Grade 30 proof	Grade 43 high test	Grade 70 transport	Grade 80 alloy	Grade 100 alloy
1/4	1,300	2,600	3,150	3,500	4,300
5/16	1,900	3,900	4,700	4,500	5,700
3/8	2,650	5,400	6,600	7,100	8,800
7/16	3,700	7,200	8,750		
1/2	4,500	9,200	11,300	12,000	15,000
5/8	6,900	13,000	15,800	18,100	22,600

Chain Mark Examples:					
<b>Example 1</b>	3	4	7	8	10
<b>Example 2</b>	30	43	70	80	100
<b>Example 3</b>	300	430	700	800	1000

Synthetic Webbing	
Width inches	WLL pounds
1-3/4	1750
2	2000
3	3000
4	4000

Manila Rope WLL	
Diameter Inches	WLL Pounds
3/8	205
7/16	265
1/2	315
5/8	465
3/4	640
1	1,050

Nylon Rope WLL	
Diameter Inches	WLL Pounds
3/8	278
7/16	410
1/2	525
5/8	935
3/4	1,420
1	2,520

Double Braided Nylon Rope WLL	
Diameter Inches	WLL Pounds
3/8	336
7/16	502
1/2	655
5/8	1,130
3/4	1,840
1	3,250

Wire Rope (6 x 37, Fiber Core)	
Diameter inches	WLL Pounds
1/4	1,400
5/16	2,100
3/8	3,000
7/16	4,100
1/2	5,300
5/8	8,300
3/4	10,900
7/8	16,100
1	20,900

Polypropylene Fiber Rope WLL (3-Strand and 8-Strand Constructions)	
Diameter Inches	WLL Pounds
3/8	400
7/16	525
1/2	625
5/8	925
3/4	1,275
1	2,100

Polyester Fiber Rope WLL (3-Strand and 8-Strand Constructions)	
Diameter Inches	WLL Pounds
3/8	555
7/16	750
1/2	960
5/8	1,500
3/4	1,880
1	3,300

Steel Strapping WLL	
Width x thickness Inches	WLL Pounds
1-1/4 x 0.029	1,190
1-1/4 x 0.031	1,190
1-1/4 x 0.035	1,190
1-1/4 x 0.044	1,690
1-1/4 x 0.05	1,690
1-1/4 x 0.057	1,925
2 x 0.044	2,650
2 x 0.05	2,650